

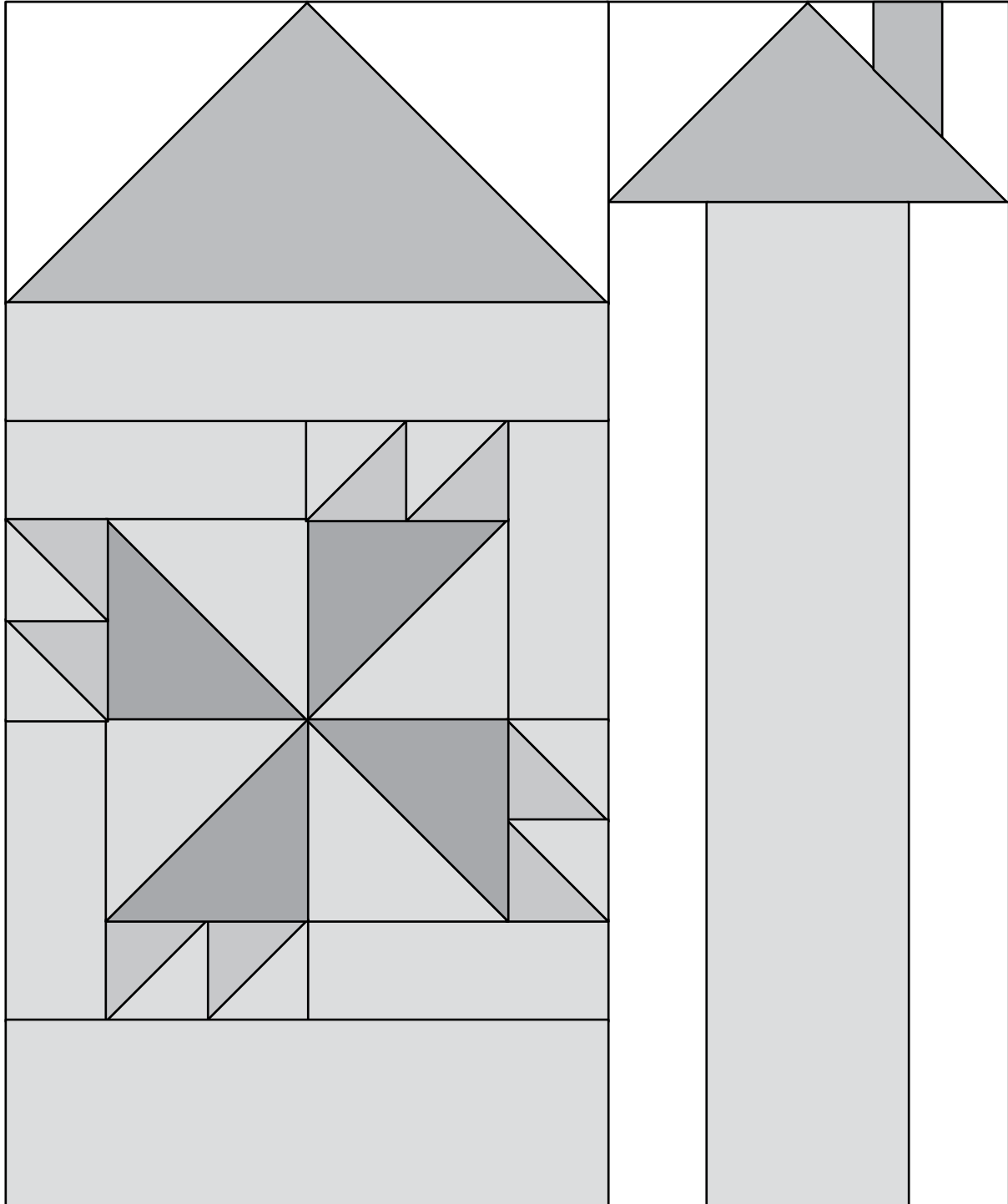

moda

Be My Neighbor

Block 2
15" x 18" finished



General Information

- These are very scrappy blocks. Mix your favorite Moda prints to create your colorful neighborhood!
- Share your blocks and final quilt at #BeMyNeighbor. We'd love to see your results!

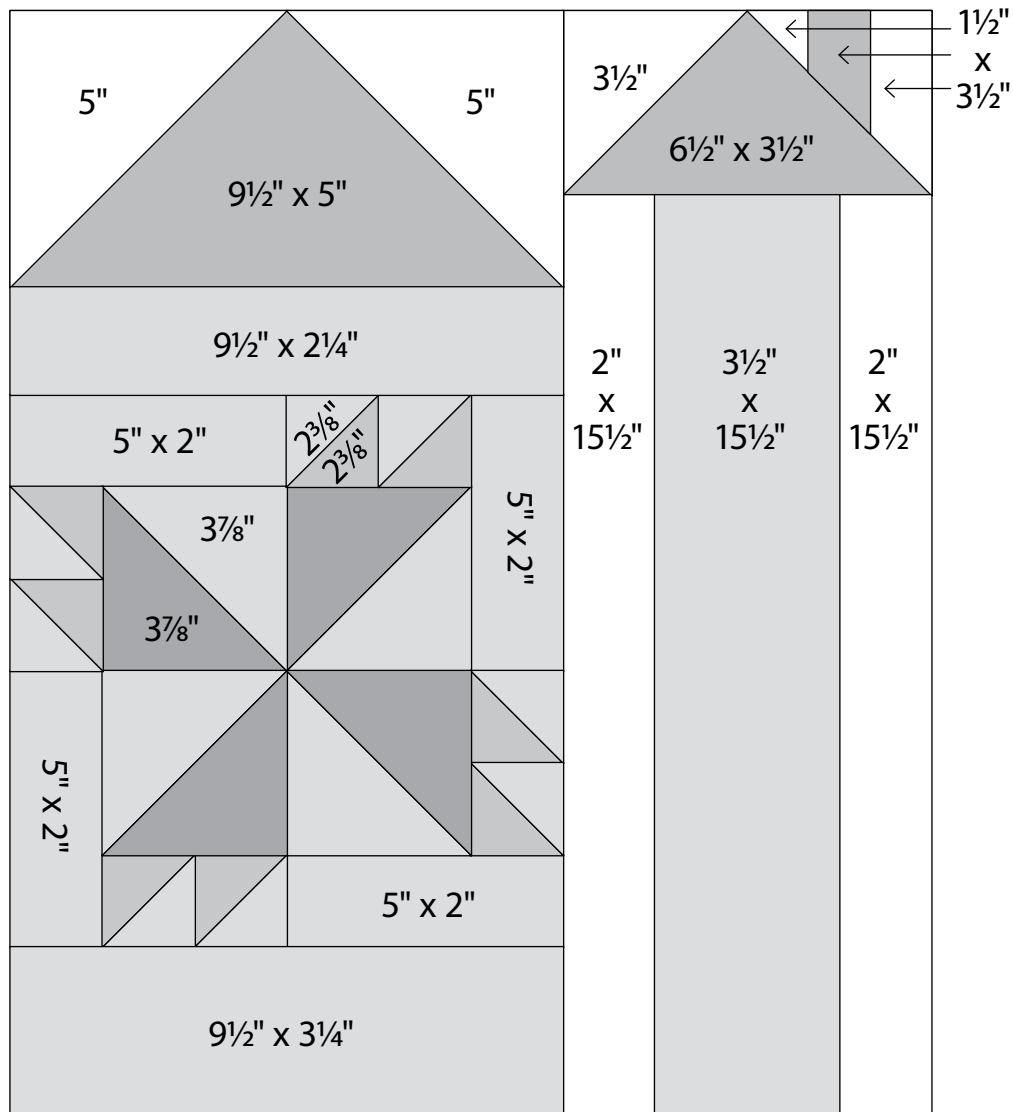

Block 2
15½" x 18½" unfinished

Cutting

House

- 1–9½" x 3¼" rectangle
- 1–9½" x 2¼" rectangle
- 4–5" x 2" rectangles
- 2–3⅞" squares
 - cut in half once on the diagonal to make 4 half-square triangles
- 4–2⅜" squares
 - cut in half once on the diagonal to make 8 half-square triangles

House Roof

- 1–9½" x 5" rectangle

Pinwheel

- 2–3⅞" squares
 - cut in half once on the diagonal to make 4 half-square triangles

Pinwheel Points

- 4–2⅜" squares
 - cut in half once on the diagonal to make 8 half-square triangles

Tower

- 1–3½" x 15½" rectangle

Tower Roof

- 1–6½" x 3½" rectangle

Tower Chimney

- 1–3½" x 1½" rectangle

Background

- 2–5" squares
- 1–3½" square
- 2–3½" x 1½" rectangles
- 2–2" x 15½" rectangles



Be My Neighbor

moda

Block 2 is 15" x 18" finished.

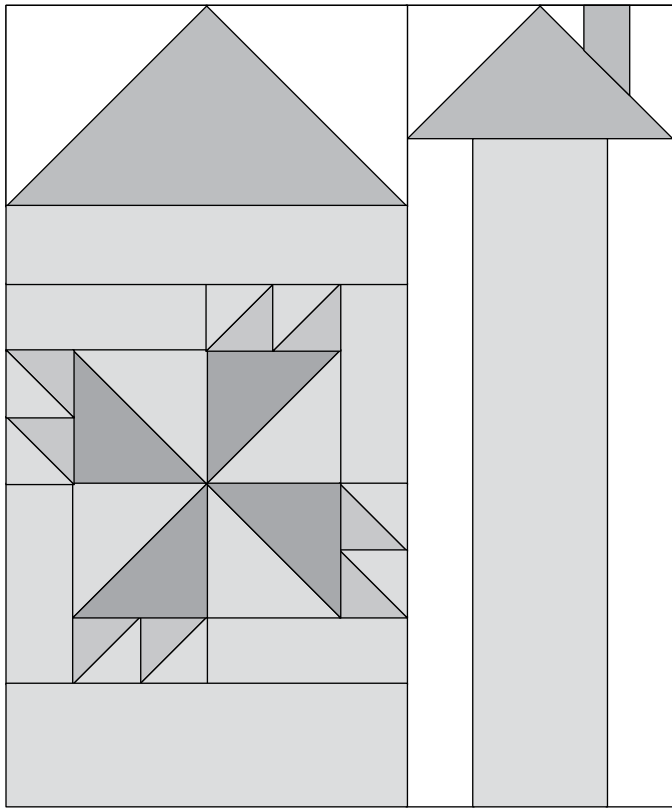

Construction

Use 1/4" seams. Press in the direction of the arrows in the diagrams.

1 House Roof

Draw a diagonal line from corner to corner on the wrong side of 2–5" background squares. Layer a 5" marked background square, right sides together, on 1–9 1/2" x 5 roof rectangle as shown. Sew on the diagonal line. Trim 1/4" from the sewn line. Press to reveal the triangle. Repeat on the opposite end of the same rectangle. Make 1.

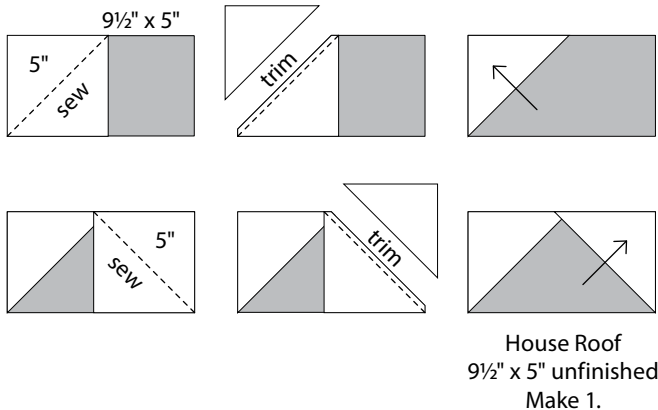

2 Pinwheel with points

(A) Join one 2 3/8" house and one 2 3/8" point half-square triangle to make a 2" point half-triangle square. Make 8. Join 2 HTSs to make 1 point pair. Make 4.

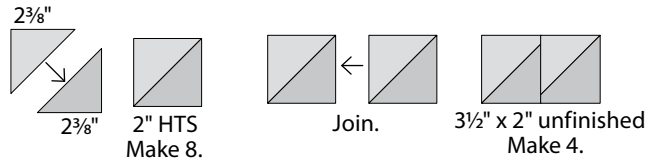

(B) Join one 3 7/8" house and one 3 7/8" pinwheel half-square triangle to make a 3 1/2" pinwheel half-triangle square. Make 4.

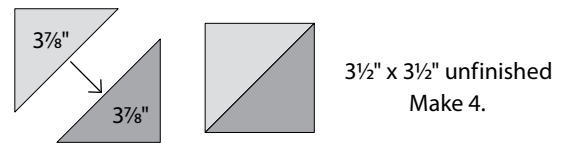

(C) Assemble a pointed pinwheel as shown.

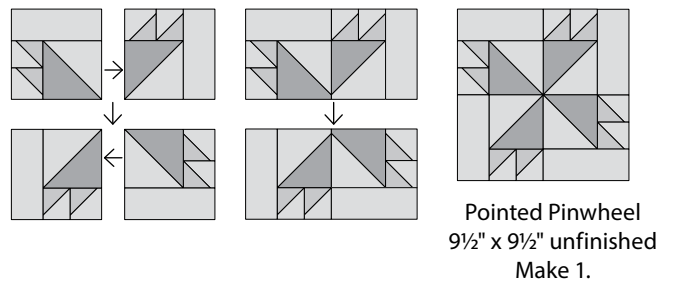
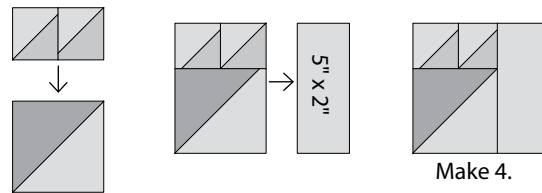

3 Assemble the house as shown.

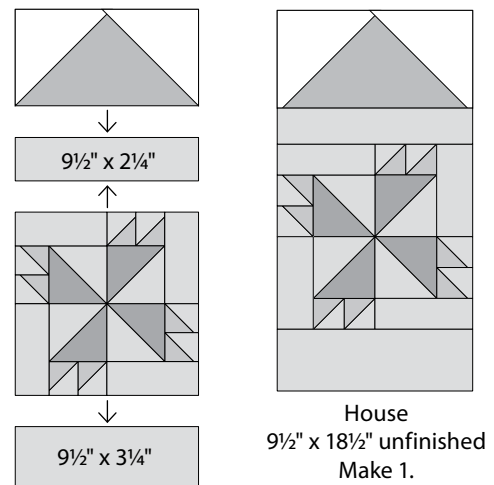

4 Assemble the tower.

(A) Join 2-1½" x 3½" backgrounds and 1-1½" x 3½" chimney to make the chimney.

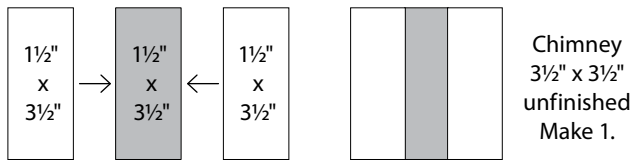

(B) Draw a diagonal line from corner to corner on the wrong side of the chimney square and a 3½" background square. Layer the marked background square, right sides together, on 1-6½" x 3½" roof rectangle as shown. Sew on the diagonal line. Trim ¼" from the sewn line. Press to reveal the triangle. Repeat on the opposite end of the same rectangle using the marked chimney square. Make 1.

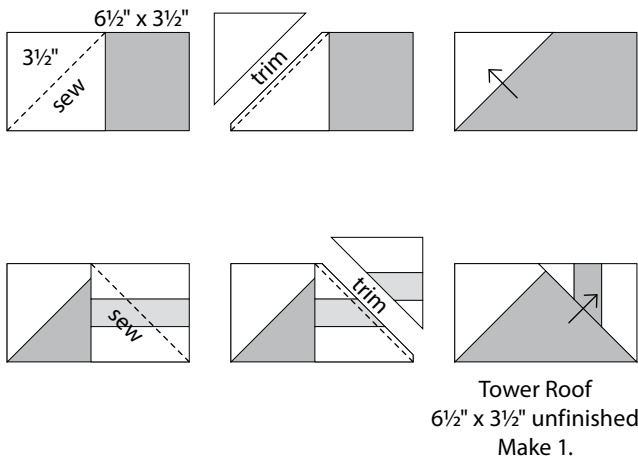

(C) Join 2-2" x 15½" backgrounds and 1-3½" x 15½" tower as shown.

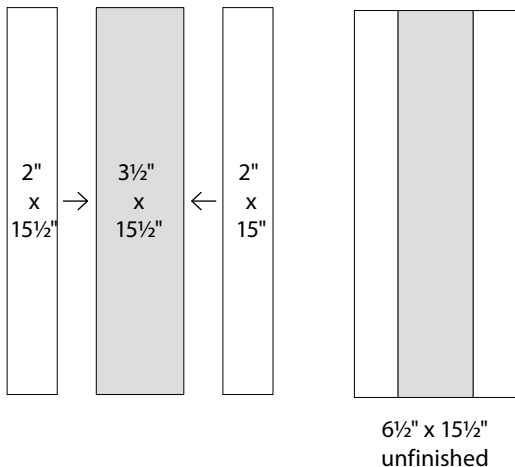

(C) Add the roof to finish the tower.

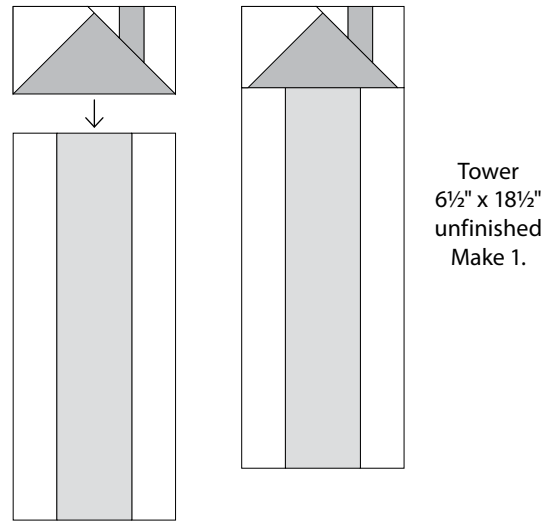

moda

5 Assemble the block as shown.

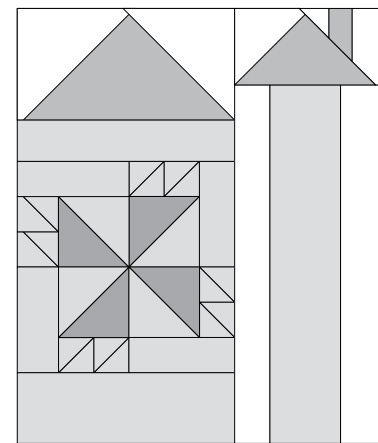
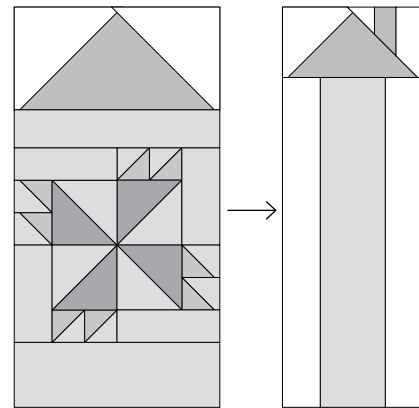

Block 2
15½" x 18½" unfinished